

MagicAir

Einbaudetails, Beispiele

Neubau

- Einbau seitlich neben Fenster
- Einbau in Wand
- Einbau in Sturz
- Einbau in Holzfassade, seitlich

Altbau

- Einbau in Brüstung
- Einbau in Sturz

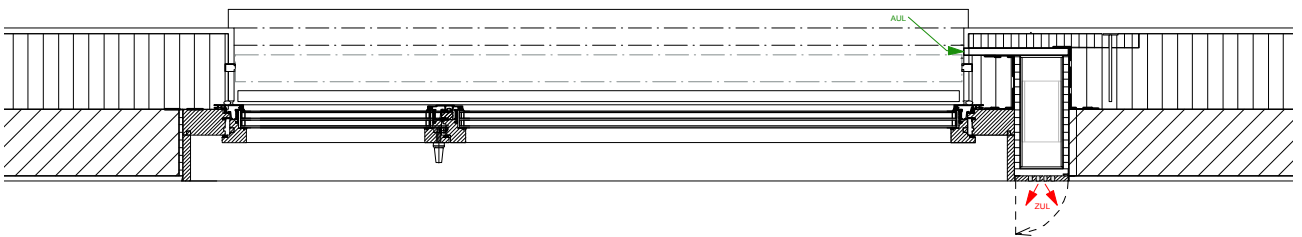
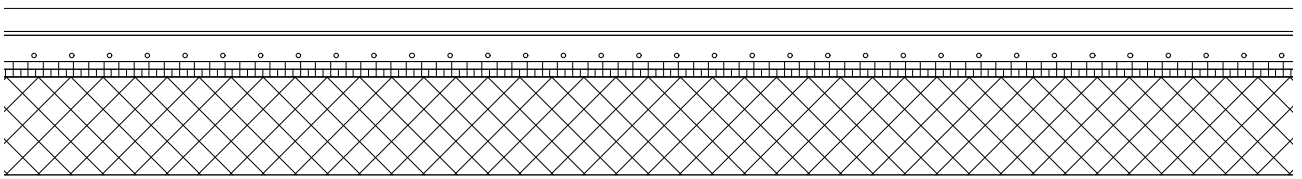
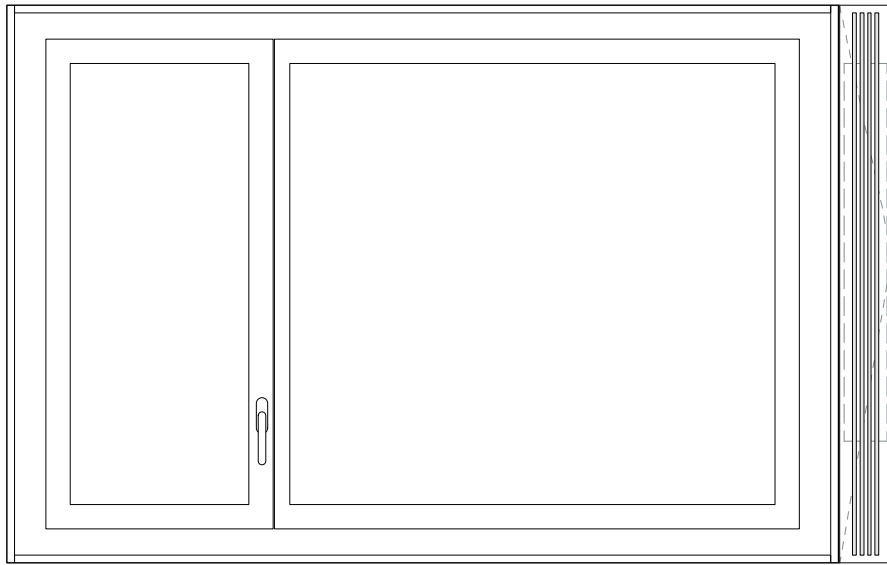
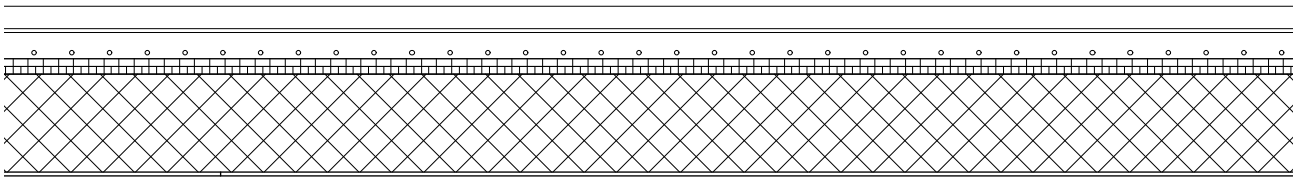

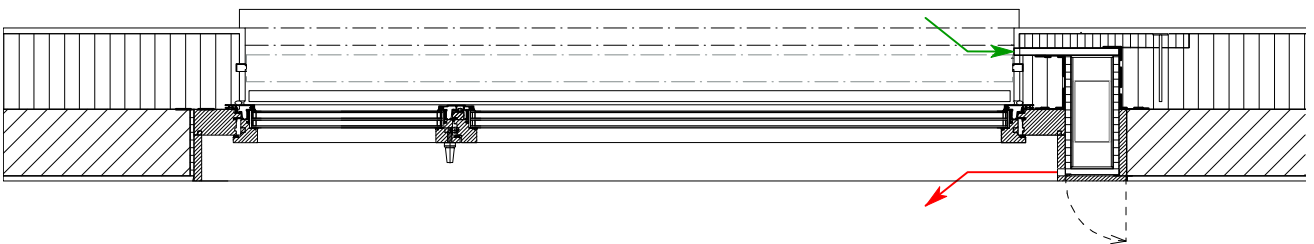
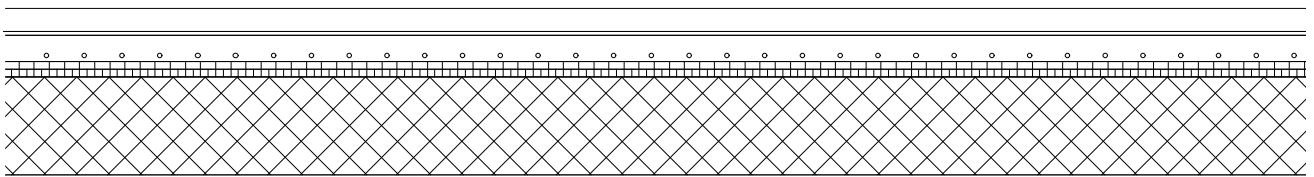
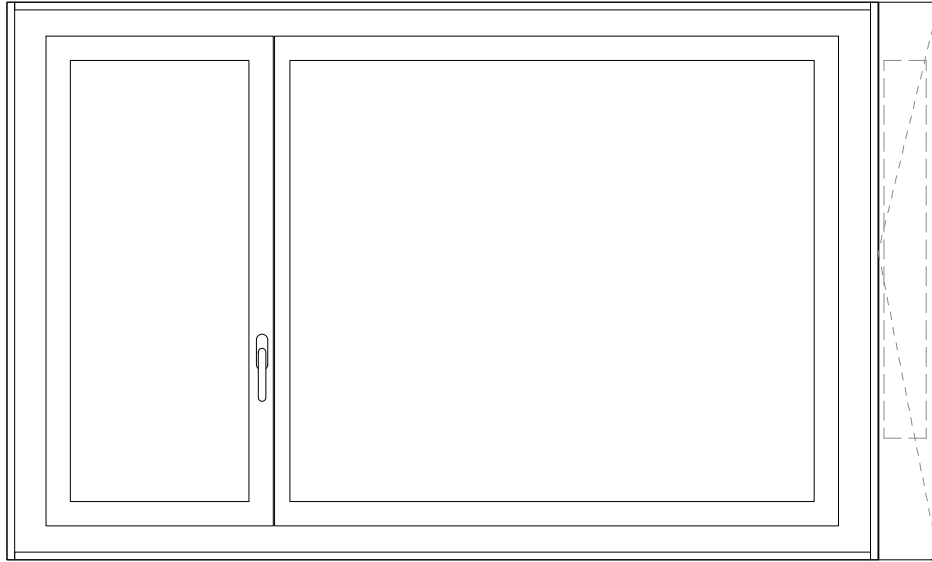
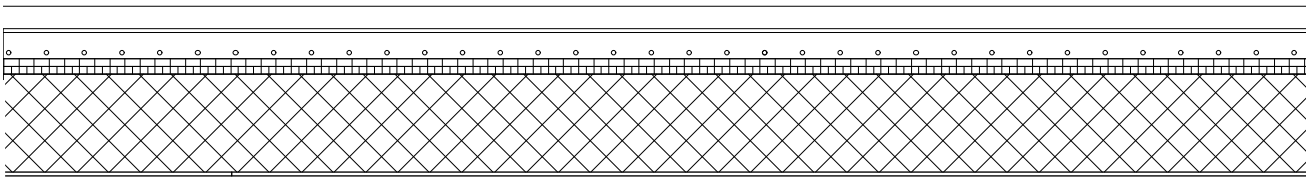

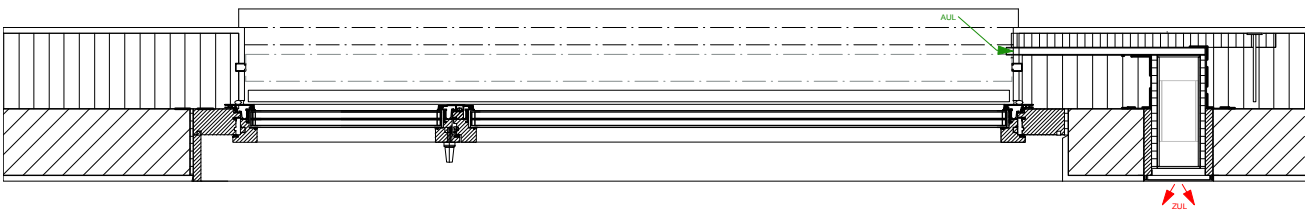
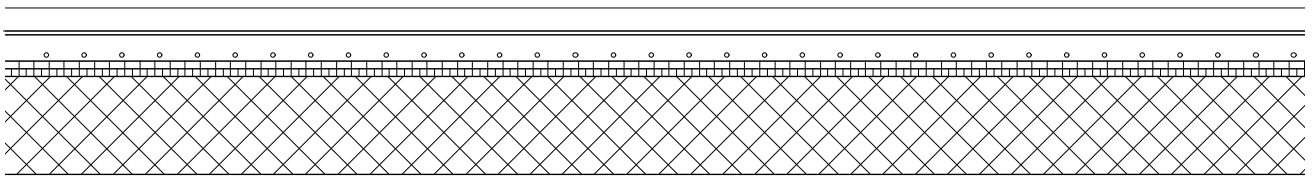
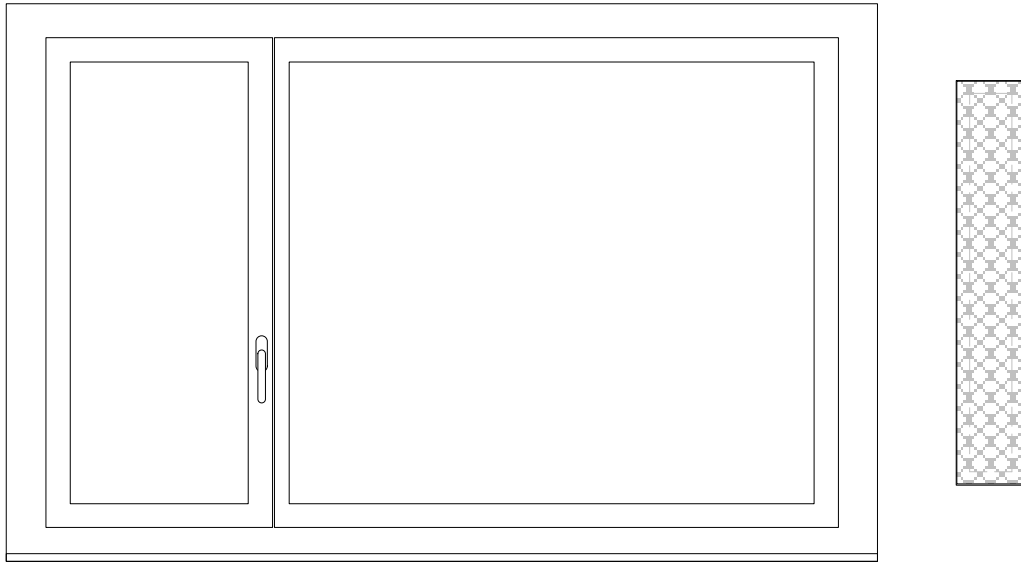
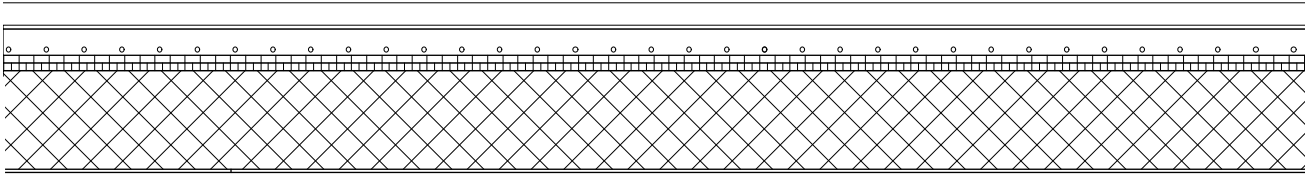

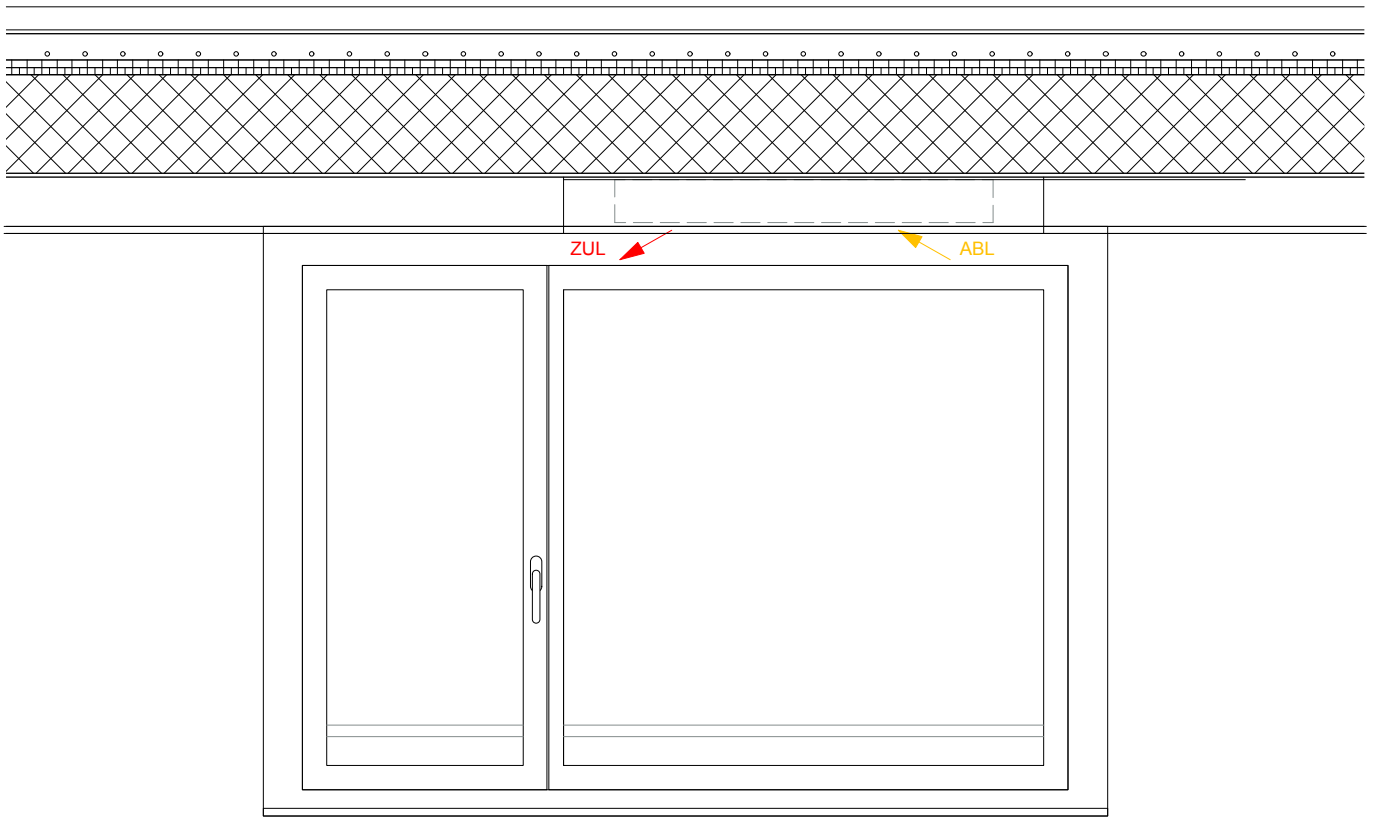

ANSICHT INNEN

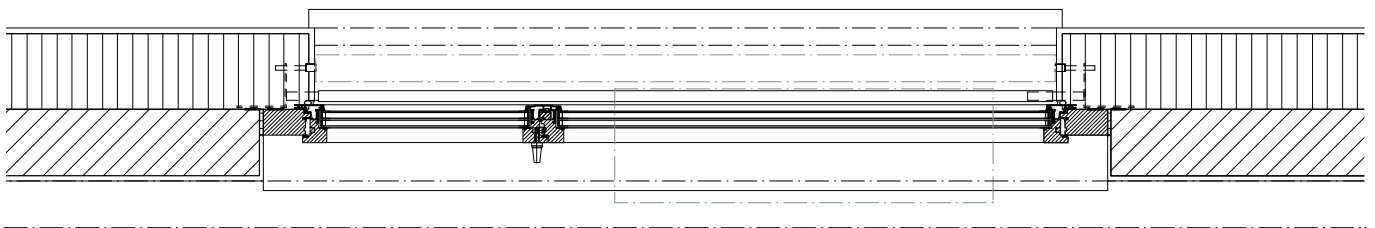

HORIZONTALSCHNITT

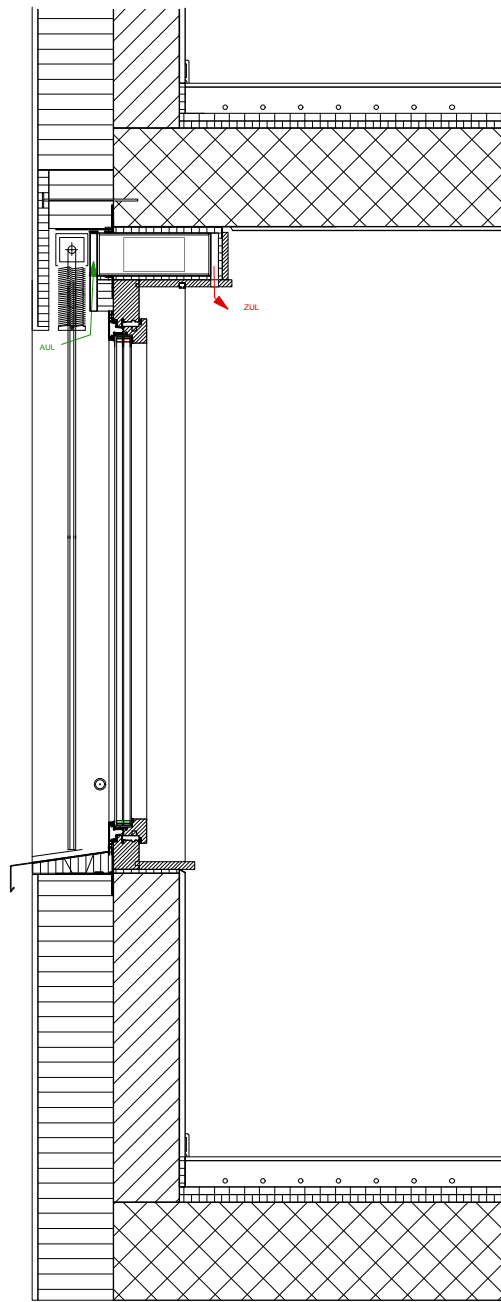

VERTIKALSCHNITT

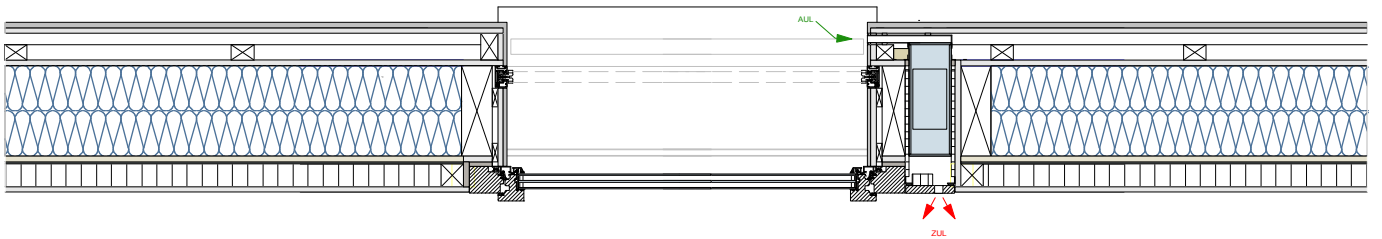
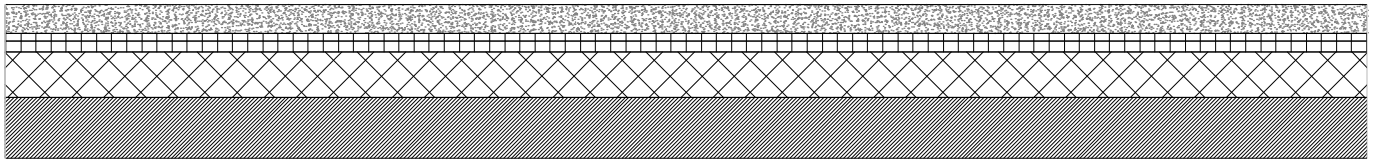
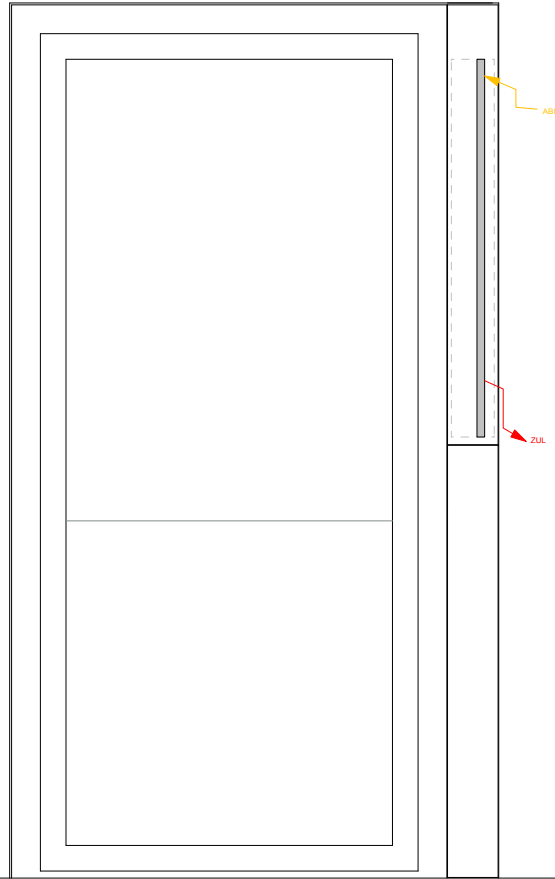
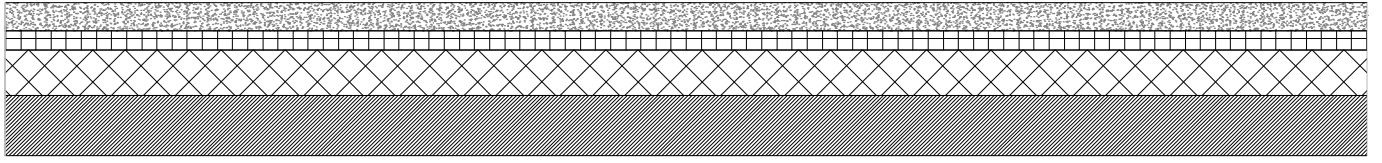

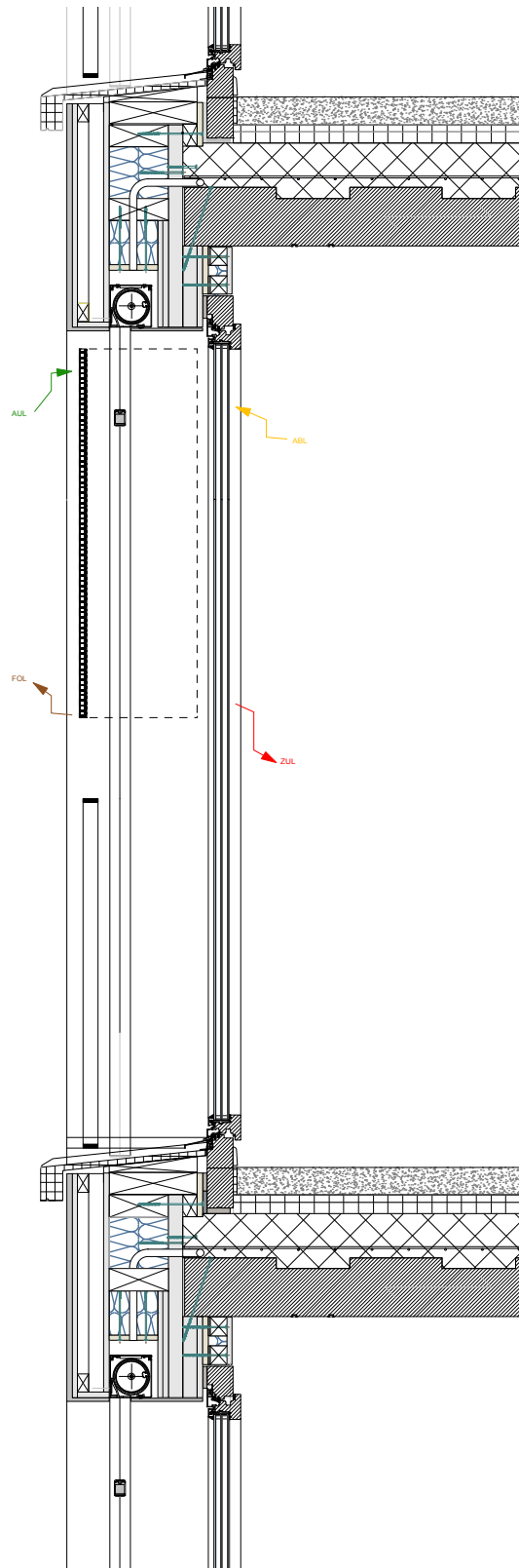

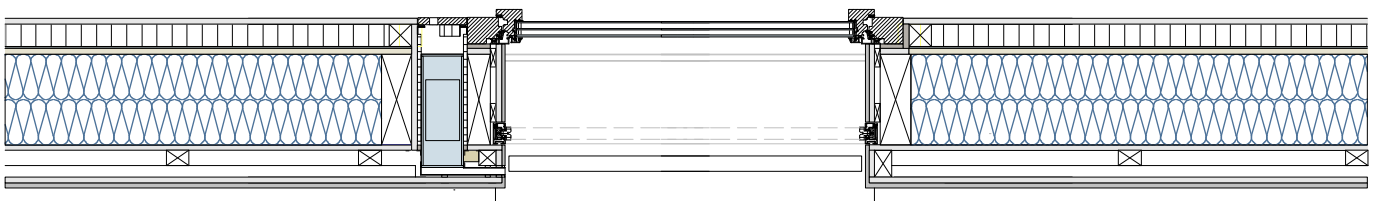
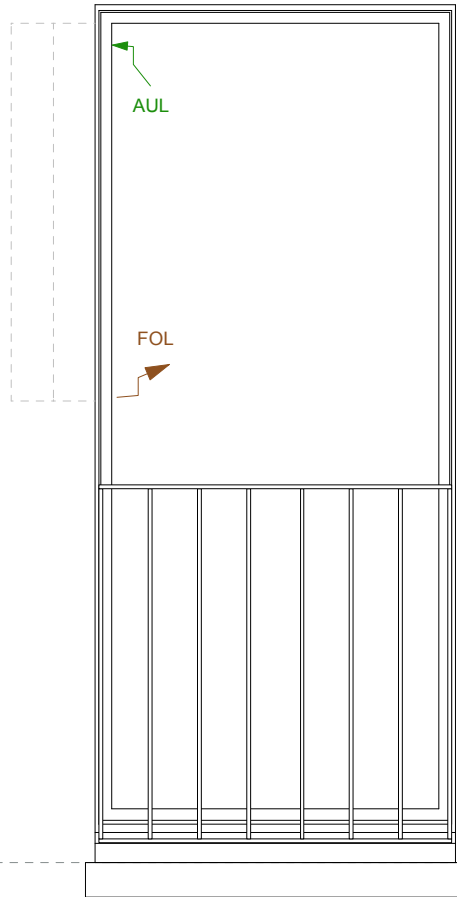

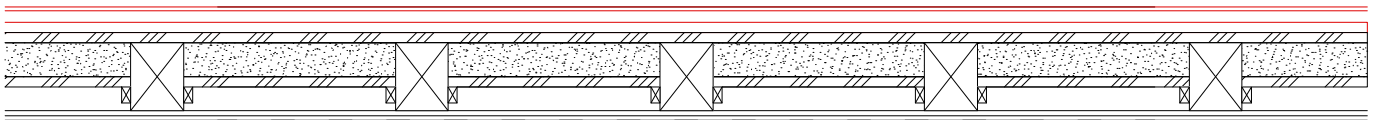
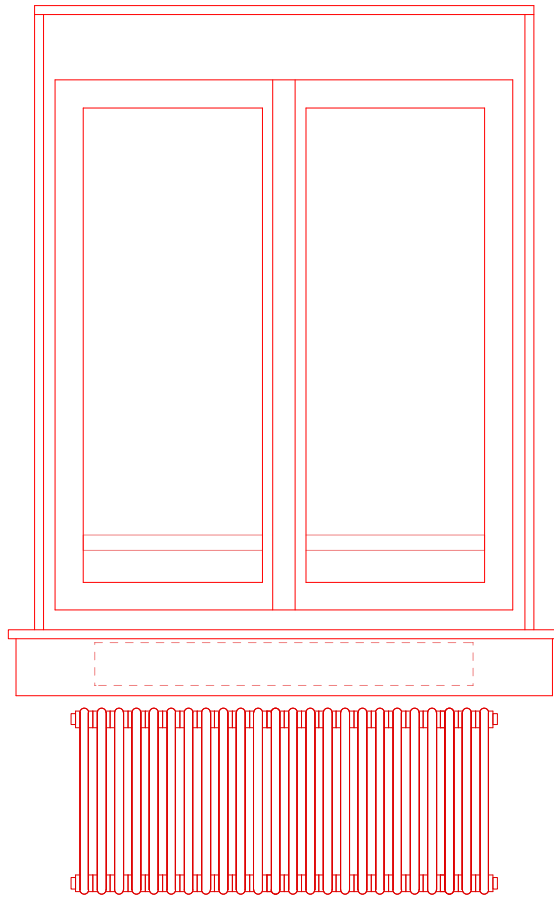
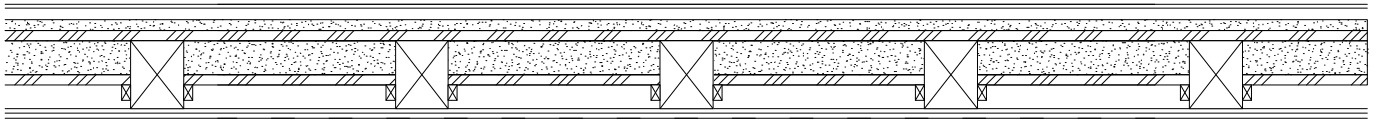

ANSICHT INNEN

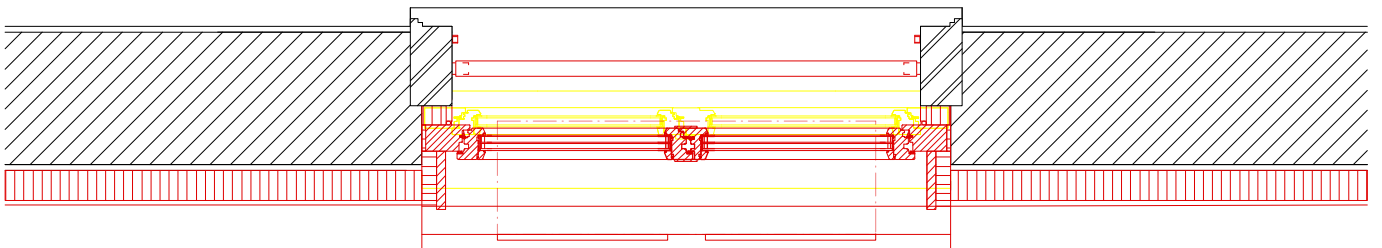

HORIZONTALSCHNITT

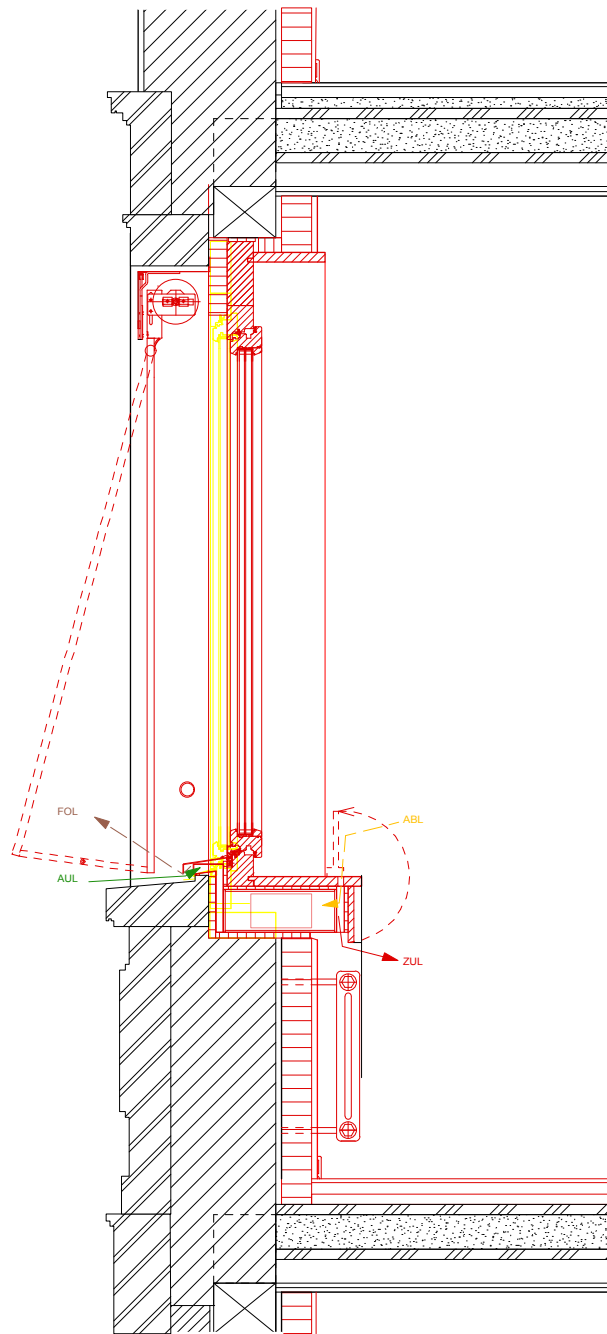

VERTIKALSCHNITT

AUSSENWAND MIT INNENDÄMMUNG

- Aussenputz	15 mm
- Mischmauerwerk	350 - 550 mm
- Innendämmung, diffusionsoffen (z.B. Kalziumsilikatplatten oder Kork)	80 mm
- Innenputz, mineralisch	15 mm

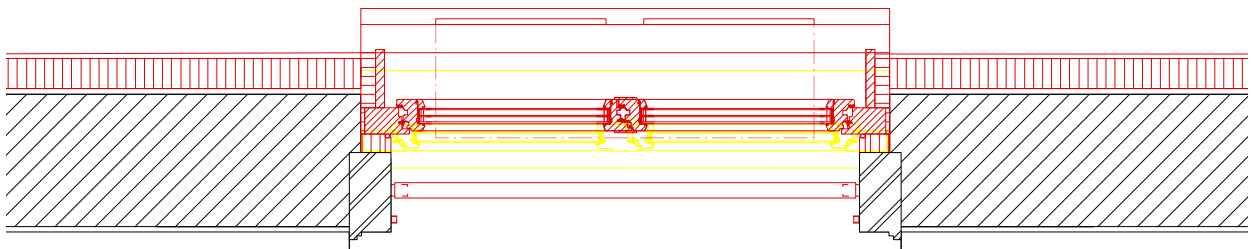
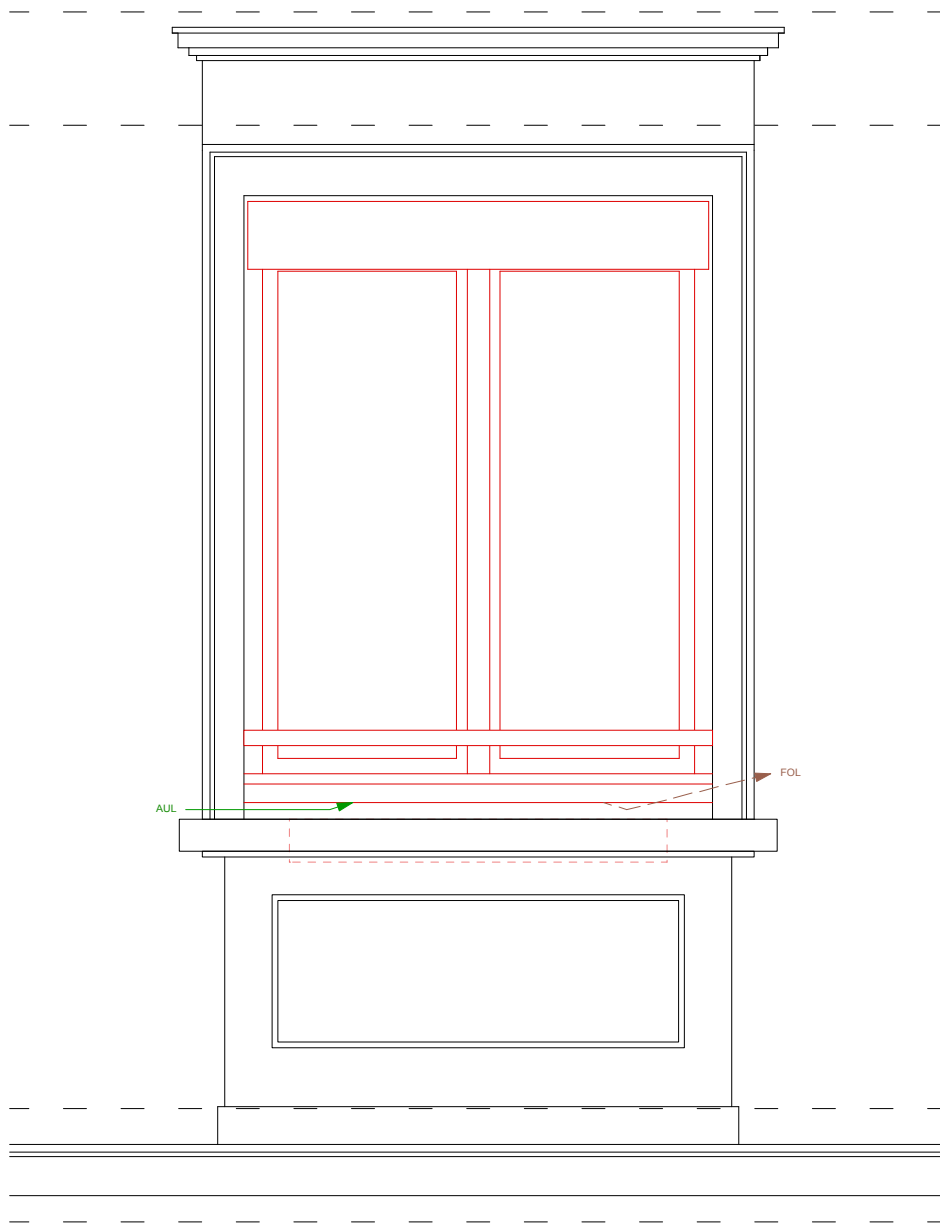

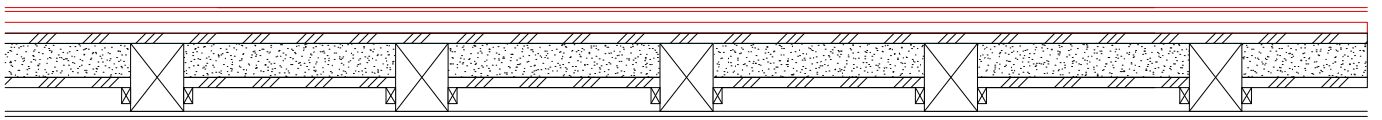
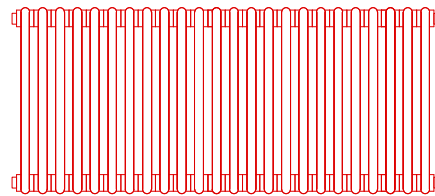
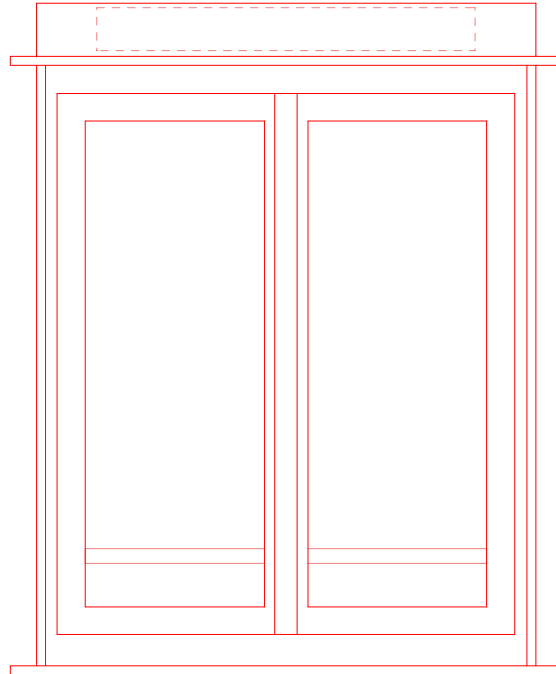
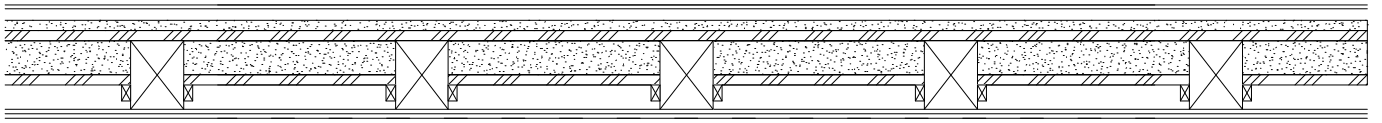

ANSICHT INNEN

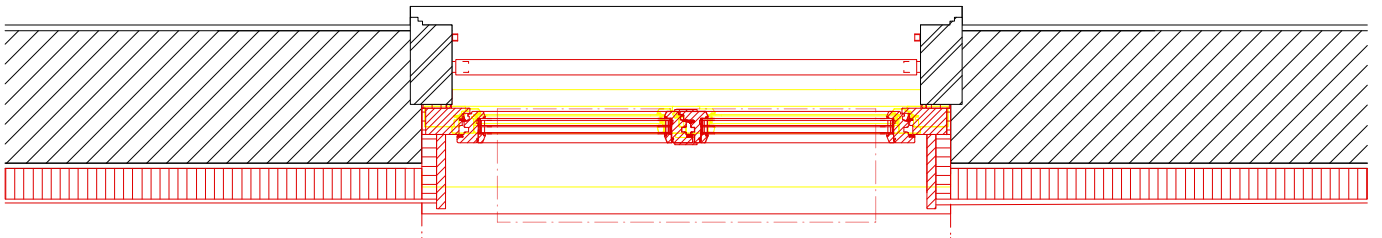

HORIZONTALSCHNITT

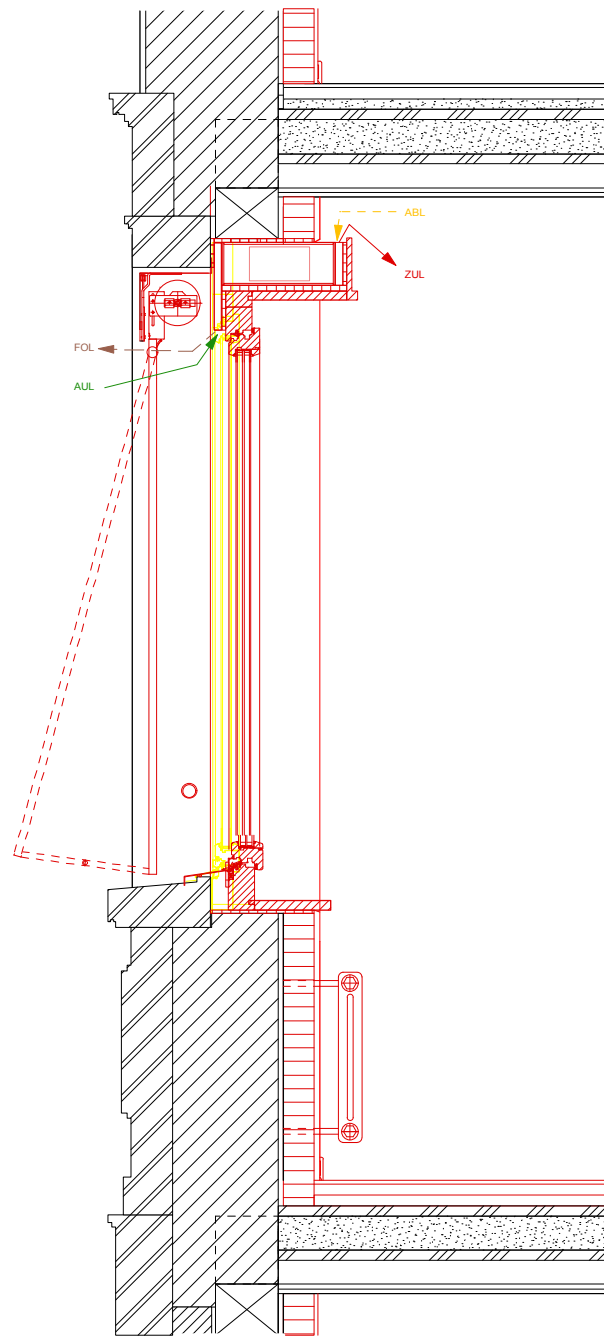

VERTIKALSCHNITT

AUSSENWAND MIT INNENDÄMMUNG

- Außenputz	15 mm
- Mischmauerwerk	350 - 550 mm
- Innendämmung, diffusionsoffen (z.B. Kalziumsilikatplatten oder Kork)	80 mm
- Innenputz, mineralisch	15 mm

